



# HENDRIKX CONCRETE PTY LTD

417 PRINCES HIGHWAY, OFFICER, VIC 3809

ABN: 12 067 076 751 ACN: 067 076 751

TEL: (03) 5943 2321 FAX: (03) 5943 1221

EMAIL: sales@hendrixxconcrete.com.au

WEBSITE: www.hendrixxconcrete.com.au

LIDS:  
AVAILABLE IN GAL GRATING, CAST IRON, TERRA FIRMA, CONCRETE

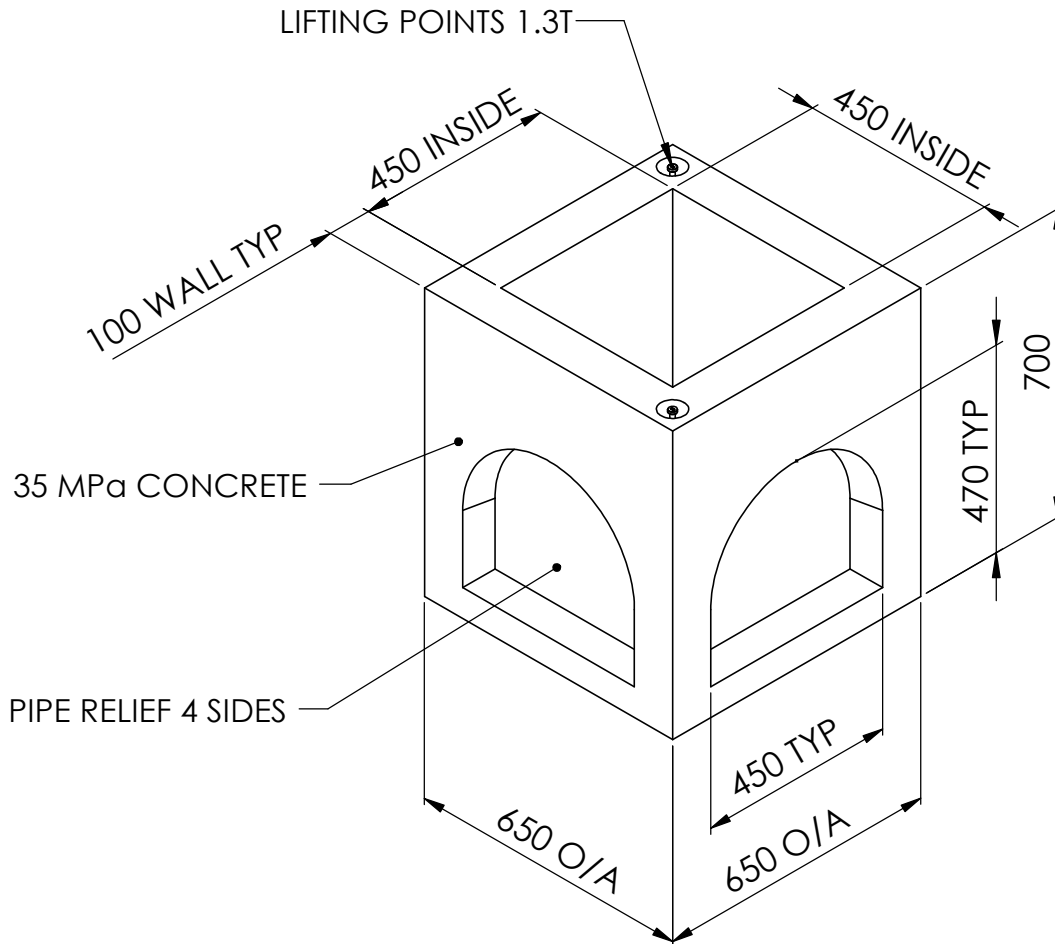

450 x 450 x 600 CONCRETE PIT  
WEIGHT = 400 kg

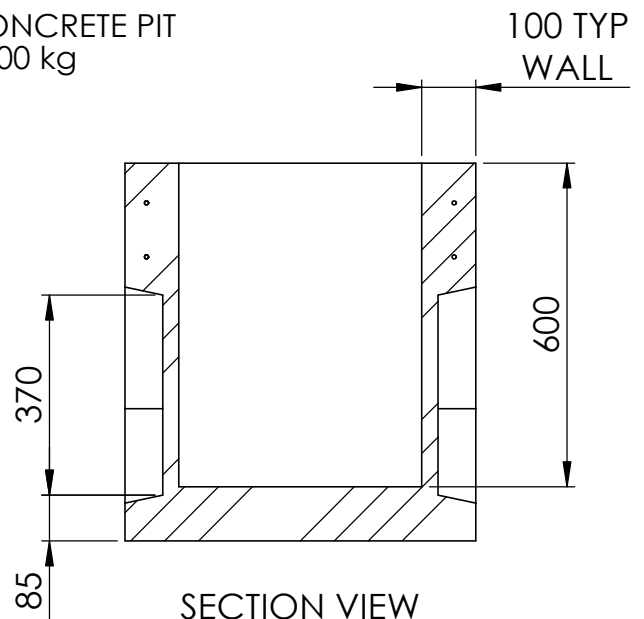

NOTES:

1. DO NOT SCALE.
2. SLIGHT TAPER ON CONCRETE UNITS.
3. MEASUREMENT IN MILLIMETRES.

Drawing Number: <b>13-HDC-011-I</b>	Title: <b>450 x 450 x 600 CONCRETE PIT - INFORMATION</b>	Drawn: <b>EV</b>	Date: <b>26.09.13</b>	Rev: <b>1</b>
--	---	---------------------	--------------------------	------------------