

HENDRIKX CONCRETE PTY LTD

ABN: 12 067 076 751

417 PRINCES HIGHWAY

TEL: 03 5943 2321

Email: sales@hendrikxconcrete.com.au

ACN: 067 076 751

OFFICER VIC 3809

FAX: 03 5943 1221

Web Site: www.hendrikxconcrete.com.au

2500 LITRE TROUGH (555 GAL)
WEIGHT 2400 KGS

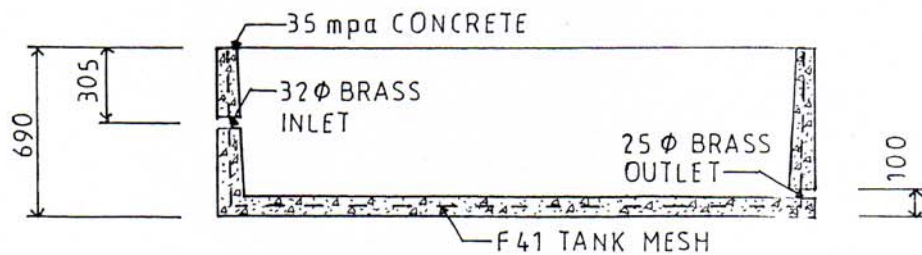
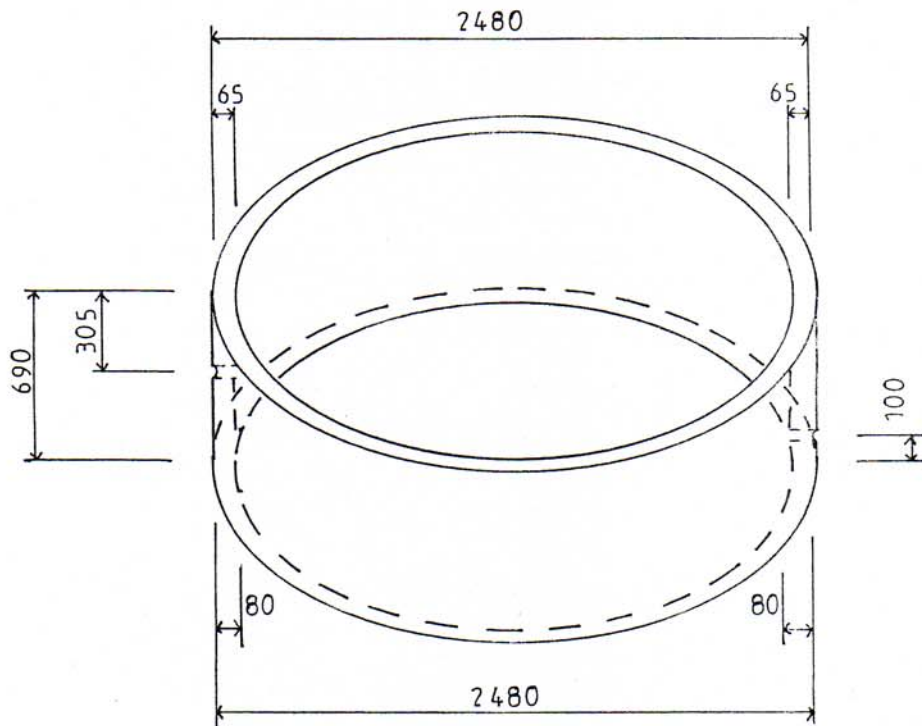

SECTION