



HENDRIKX CONCRETE PTY LTD

417 PRINCES HIGHWAY, OFFICER, VIC 3809

ABN: 12 067 076 751 ACN: 067 076 751

TEL: (03) 5943 2321 FAX: (03) 5943 1221

EMAIL: sales@hendrixxconcrete.com.au

WEBSITE: www.hendrixxconcrete.com.au

LIDS:
AVAILABLE IN GAL GRATING, CAST IRON, TERRA FIRMA, CONCRETE

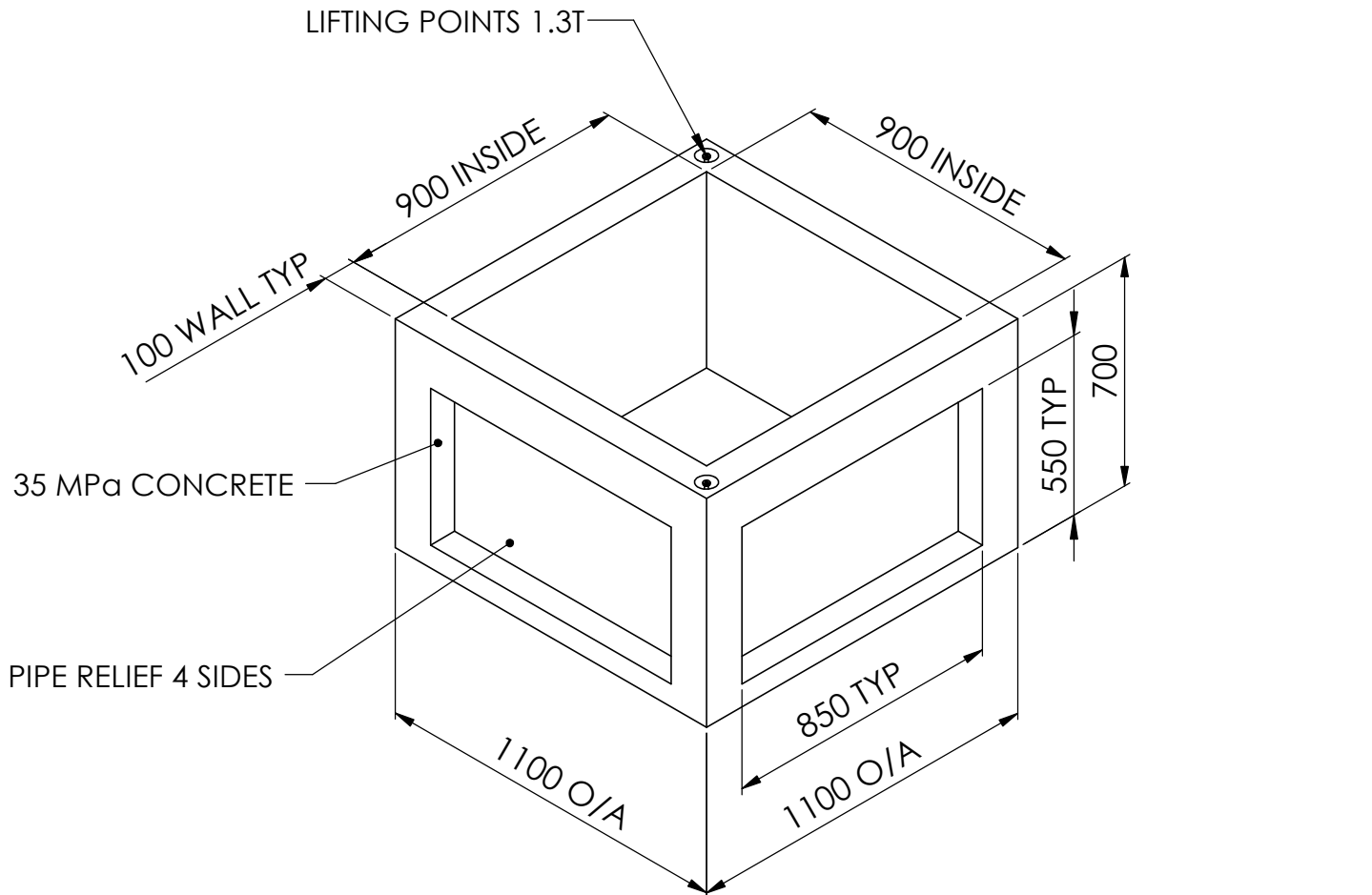

900 x 900 x 600 CONCRETE PIT
WEIGHT = 625 kg

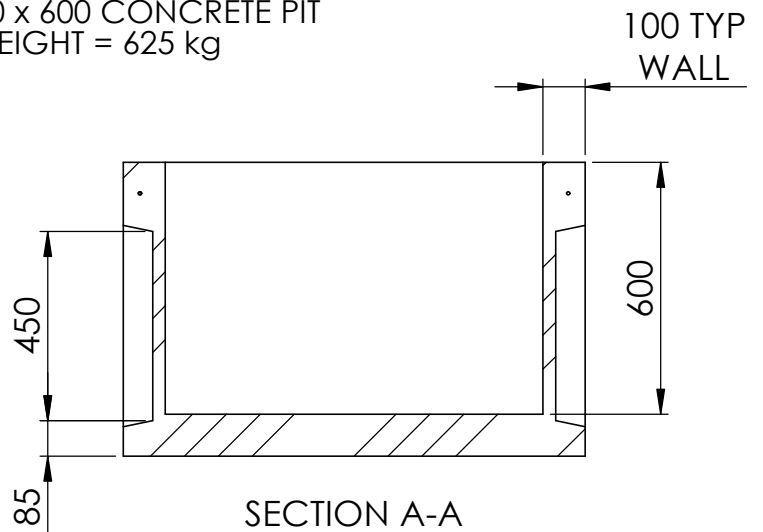

NOTES:

1. DO NOT SCALE.
2. SLIGHT TAPER ON CONCRETE UNITS.
3. MEASUREMENT IN MILLIMETRES.

Drawing Number: 13-HDC-040-I	Title: 900 x 900 x 600 CONCRETE PIT - INFORMATION	Drawn: EV	Date: 08.07.14	Rev: 1
--	---	---------------------	--------------------------	------------------